

IBS
IMPLANT Different, but Better
It's time to change

MAGICORE SYSTEM

IBS IMPLANT
www.ibsimplant.com

for minimally invasive implant surgery

INTRODUCTION

It's time to change

We've come to a time in modern implantology where various treatment techniques are now developed and can be applied to fit any clinical situation with successful outcomes.

However, whilst treating our patients, we seem to have neglected to develop treatments that reduce the damage done to them, even more so, than during the times of Branemark's bone focused implants.

It follows that the direction modern implant treatments must go is toward development and research into treatment methods that reduce the damage done to soft tissue and bone, while also minimizing the use of artificial and exogenous materials.

Since 2003, IBS Implant has been researching this very endeavor, and has reached a level of technology that enables the design and production of a system that is specific and optimal for minimally invasive implant treatments.

IBS Implant will not stop at merely being recognized as an outstanding implant system. We will continually do our best in providing the world with an implant system that is desired and needed by clinicians and patients for centuries to come.

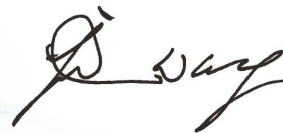

Je-Won Wang D.D.S., M.S.

CEO

INNOBIOSURG CO., Ltd.



IBS
IMPLANT



CONTENTS

History of IBS Implant	03
MagiCore (Product Specification)	07
MagiCore KIT	18
MagiCore (Surgical Protocol)	27

History of IBS Implant

2003

- Start of research for minimally invasive implant system

2007

- Magic Surgical System developed

2008

- A new implant and surgical system developed for minimally invasive surgery
- IBS Implant HQ established

2009

- Manufacturing plant established
- Recognized as venture company
- KFDA certified

2011

- Magic Kit FDA certified
- Pakistan, Iran, Turkey distribution begins
- Research institute established

2012

- Recognized as promising start-up by Korean National Government
- Malaysia, Vietnam, Philippines distribution begins

2013

- MOU with Wonkwang University Osteogenesis Research Center
- First IBS Implant World Symposium held
- HQ expansion
- Greece, Spain, UAE, India, Egypt distribution begins

2014

- MOU with Wonkwang University
- China NMPA Certified
- Bulgaria, Iraq, Czech Rep., Italy, Chile distribution begins

2015

- 2nd IBS Implant World Symposium held in Antalya, Turkey
- GOST-R Russia Certified
- U.S.A subsidiary established
- Poland, Germany, Thailand, Kyrgyzstan, France, Indonesia distribution begins
- 11 national field offices established
- FDA Class II Certified
- Japan PMDA Certified
- Fatigue test machine acquired

2016

- 12 national field offices in place
- Distribution in 40 nations throughout Asia, Europe, and Middle East
- China subsidiary established
- Europe subsidiary established
- MOU with SSPM Dental University in Russia
- MOU with Mustansiria University in Iraq
- U.S.A. Clinical Training Center established
- Monthly Training Courses held in U.S.A.
- 1st IBS Europe meeting held
- 1st IBS Implant Turkey Congress held
- 3rd IBS Implant World Symposium held in Korea
- India, Taiwan, Thailand product registrations certified
- IBS Clinical Research Institute established

2017

- SEM machine acquired
- India DCG certified
- Taiwan TFDA certified
- Academy of Minimally Invasive Implantology (AMII) established
- 3rd AMII national course completed

2018

- Kazakhstan GOST-K certified
- China factory established
- 4th IBS Implant World Symposium held in Seoul
- 11th AMII Training Course completed
- Laser Marking Machine acquired
- Laser Welding Machine acquired
- 6 additional CNC machines acquired

2019

- Vietnam, Thailand, subsidiary establishment planned
- MOU with 3 additional major international universities planned
- Bi-annual Symposium in major cities planned
- 5th AMII World Symposium planned (November)
- 21st AMII Training Course completion planned

2020~2021

- U.S.A factory establishment planned
- Japan, India, UAE, Africa subsidiaries planned
- MOUs with 7 additional major int'l universities planned
- Yearly IBS user meetings planned
- Yearly AMII World Symposium planned
- Quarterly Research meetings planned
- Korea, USA, Europe, and Russia expansion of AMII and research activities
- 3rd Main factory establishment planned

| WORLDWIDE LOCATIONS

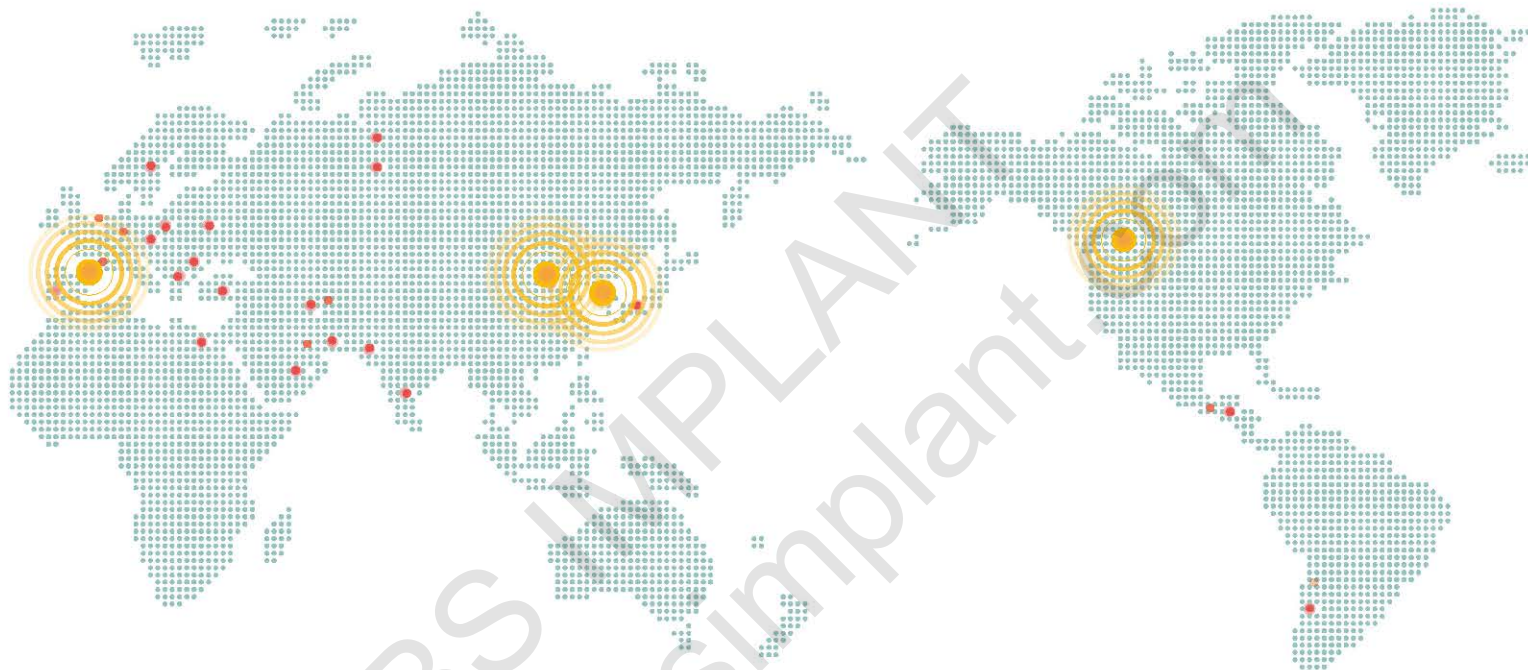

INNOBIOSURG HQ, KOREA.



INNOBIOSURG OF AMERICA.



INNOBIOSURG OF EUROPE.



INNOBIOSURG OF CHINA.

- France
- Hungary
- Bulgaria
- Chile
- Czech Republic
- Egypt

- Iraq
- Japan
- Kosovo
- Kyrgyzstan
- Poland
- Philippines

- Greece
- Pakistan
- Guatemala
- India
- Indonesia
- Iran

- Russia
- Spain
- Turkey
- Thailand
- U.A.E
- U.K

International Recognition

- Recognized for the creation of the new 4th original paradigm of implant design.
- Recognized by pioneering nations such as the US, Europe, etc. as Korea's first Premium Brand Implant.
- Asia's first brand to be in mutual research activities with European universities on minimally invasive implant surgery.

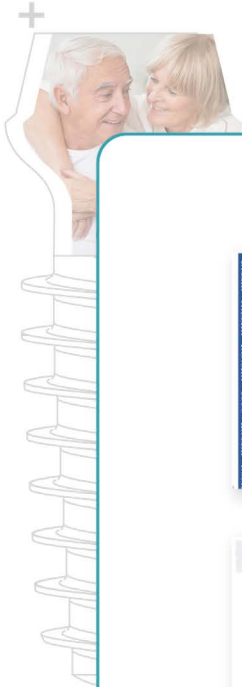

CERTIFICATES



The World's 4th Paradigm of Original Implant Design
The World's 1st Minimally Invasive Implant

MAGICORE®

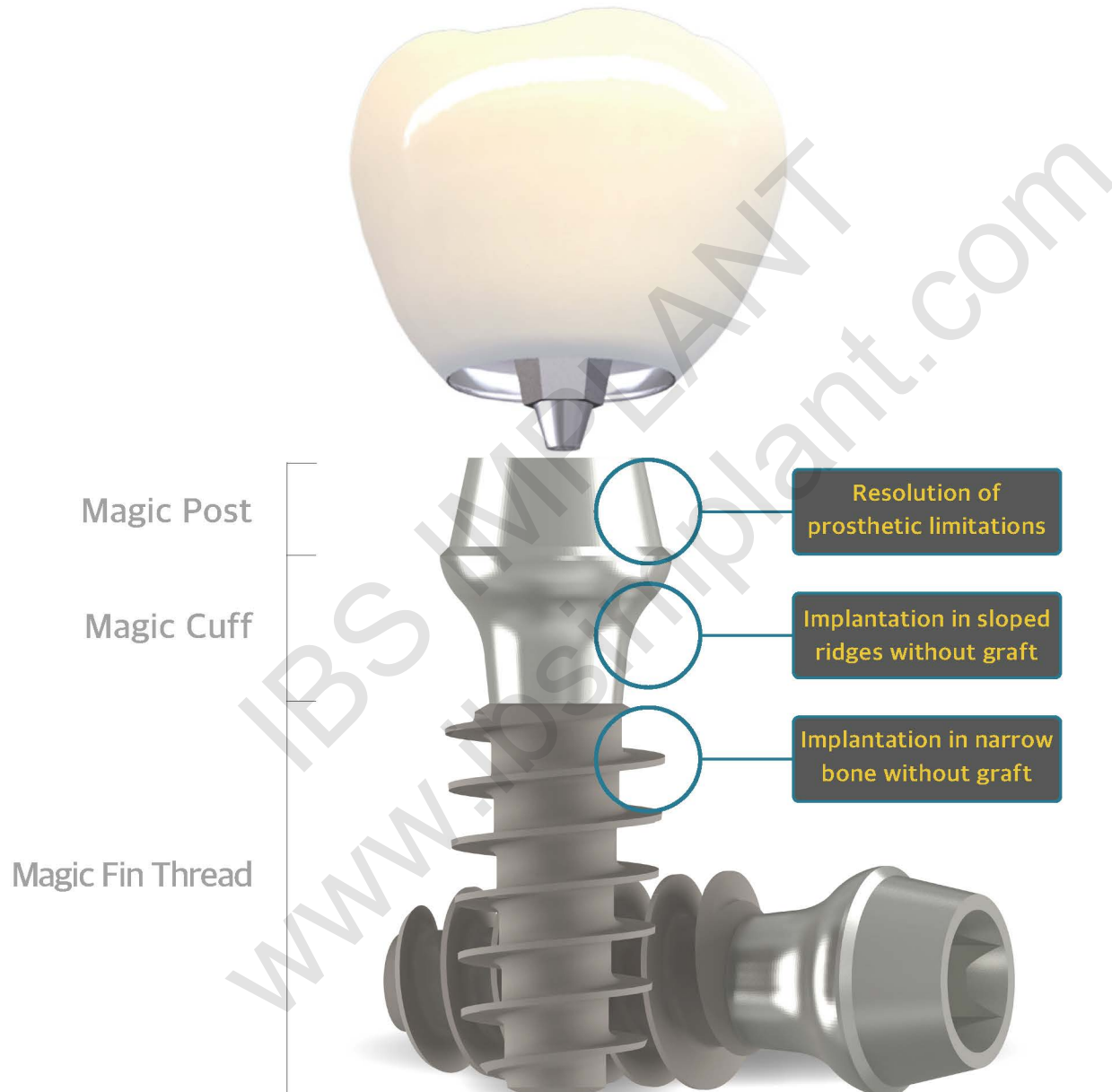

Prestige Award Winner for "Most Innovative Patent"

Korean National Ministry of Science and Technology

(Patents: 10-1586082, 10-1388846)

Prosthetic Flow for MAGICORE®

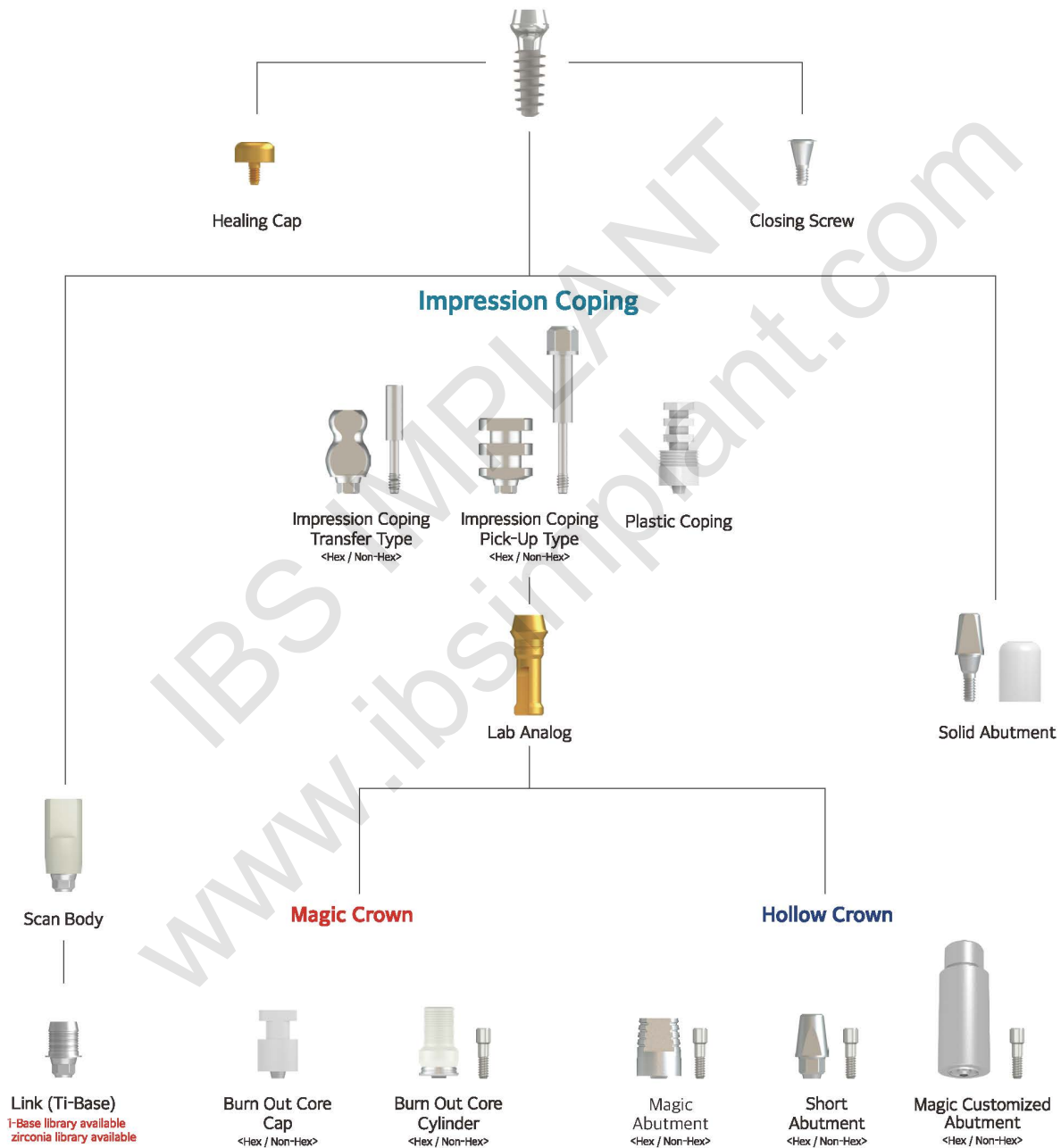

* 140% of actual size (Exclude Magic Customized Abutment)

MagiCore Narrow Fixture (uses Ø4.0 abutment)

Fixture Size

Fixture Diameter Ø3.0

[mm]

Fixture Part			Code	Cuff(C)
Diameter(D)	Length(L)	Magic Cuff		
Ø3.0	11	2	401M3011	1
		3	402M3011	2
		4	403M3011	3
		5	404M3011	4
	13	2	401M3013	1
		3	402M3013	2
		4	403M3013	3
		5	404M3013	4
	15	2	401M3015	1
		3	402M3015	2
		4	403M3015	3
		5	404M3015	4

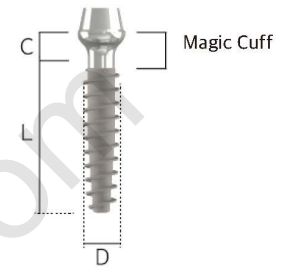

■ Available in selected regions only

Fixture Diameter Ø3.5

[mm]

Fixture Part			Code	Cuff(C)
Diameter(D)	Length(L)	Magic Cuff		
Ø3.5	11	2	401M3511	1
		3	402M3511	2
		4	403M3511	3
		5	404M3511	4
	13	2	401M3513	1
		3	402M3513	2
		4	403M3513	3
		5	404M3513	4
	15	2	401M3515	1
		3	402M3515	2
		4	403M3515	3
		5	404M3515	4

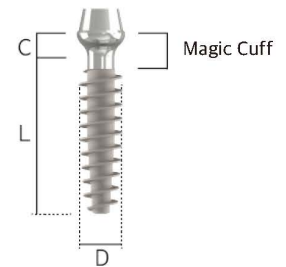

■ Available in selected regions only

MagiCore Fixture (uses Ø4.5 abutment)

Fixture Size

Fixture Diameter Ø4.0

[mm]

Fixture Part			Code	Cuff(C)
Diameter(D)	Length(L)	Magic Cuff		
Ø4.0	9	2	451M4009	1
		3	452M4009	2
		4	453M4009	3
		5	454M4009	4
	11	2	451M4011	1
		3	452M4011	2
		4	453M4011	3
		5	454M4011	4
	13	2	451M4013	1
		3	452M4013	2
		4	453M4013	3
		5	454M4013	4

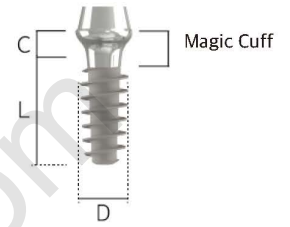

Fixture Diameter Ø4.5

[mm]

Fixture Part			Code	Cuff(C)
Diameter(D)	Length(L)	Magic Cuff		
Ø4.5	7	2	451M4507	1
		3	452M4507	2
		4	453M4507	3
		5	454M4507	4
	9	2	451M4509	1
		3	452M4509	2
		4	453M4509	3
		5	454M4509	4
	11	2	451M4511	1
		3	452M4511	2
		4	453M4511	3
		5	454M4511	4
	13	2	451M4513	1
		3	452M4513	2
		4	453M4513	3
		5	454M4513	4

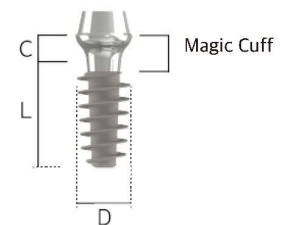

MagiCore Fixture (uses Ø5.5 Abutment)

Fixture Size

Fixture Diameter Ø5.0 [mm]

Fixture Part			Code	Cuff(C)
Diameter(D)	Length(L)	Magic Cuff		
Ø5.0	7	2	551M5007	1
		3	552M5007	2
		4	553M5007	3
		5	554M5007	4
	9	2	551M5009	1
		3	552M5009	2
		4	553M5009	3
		5	554M5009	4
	11	2	551M5011	1
		3	552M5011	2
		4	553M5011	3
		5	554M5011	4

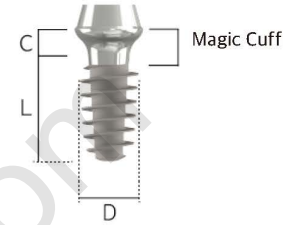

Fixture Diameter Ø5.5 [mm]

Fixture Part			Code	Cuff(C)
Diameter(D)	Length(L)	Magic Cuff		
Ø5.5	7	2	551M5507	1
		3	552M5507	2
		4	553M5507	3
		5	554M5507	4
	9	2	551M5509	1
		3	552M5509	2
		4	553M5509	3
		5	554M5509	4
	11	2	551M5511	1
		3	552M5511	2
		4	553M5511	3
		5	554M5511	4

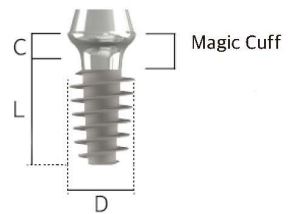

MagiCore Fixture (uses Ø5.5 Abutment)

Fixture Size

Fixture Diameter Ø6.0

[mm]

Fixture Part			Code	Cuff(C)
Diameter(D)	Length(L)	Magic Cuff		
Ø6.0	7	2	551M6007	1
		3	552M6007	2
		4	553M6007	3
		5	554M6007	4
		2	551M6009	1
	9	3	552M6009	2
		4	553M6009	3
		5	554M6009	4
		2	551M6011	1
		3	552M6011	2
	11	4	553M6011	3
		5	554M6011	4

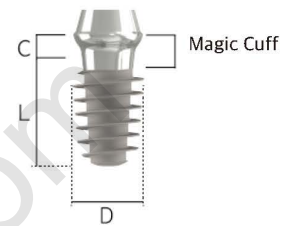

Fixture Diameter Ø6.5

[mm]

Fixture Part			Code	Cuff(C)
Diameter(D)	Length(L)	Magic Cuff		
Ø6.5	7	2	551M6507	1
		3	552M6507	2
		4	553M6507	3
		5	554M6507	4
		2	551M6509	1
	9	3	552M6509	2
		4	553M6509	3
		5	554M6509	4
		2	551M6511	1
		3	552M6511	2
	11	4	553M6511	3
		5	554M6511	4

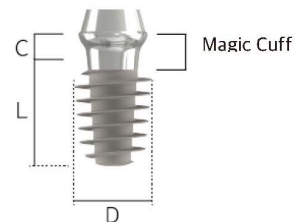

MagiCore Prosthetic Components

Healing Cap

Abutment Diameter	Color	Code
4.0	● Silver	MP CAP4.0
4.5	● Yellow	MP CAP4.5
5.5	● Silver	MP CAP5.5



■ 4.0 abutment available in selected regions only

Lab Analog

Abutment Diameter	Color	Code
4.0	● Green	MPL40
4.5	● Yellow	MPL45
5.5	● Silver	MPL55



■ 4.0 abutment available in selected regions only

Closing Screw

Abutment Diameter	Color	Code
4.0	● Green	HISCS
4.5/5.5	● Silver	HISC07



■ 4.0 abutment available in selected regions only

Impression Coping (Transfer Type)

Abutment Diameter	Type	Height	Code
4.0	Hex	Short	● MTICH40
	Hex	Long	● MTICH40L
4.5	Hex	Short	● MTICH45
	Hex	Long	● MTICH45L
5.5	Hex	Short	● MTICH55
	Hex	Long	● MTICH55L

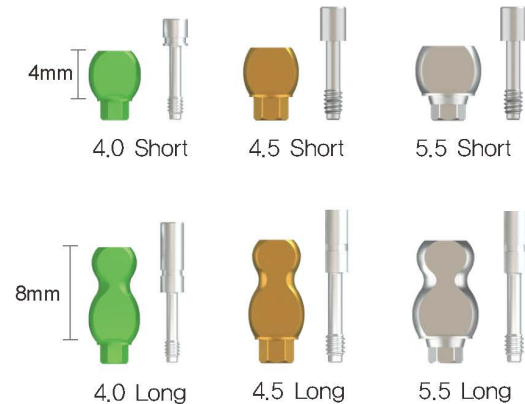

■ 4.0 abutment available in selected regions only

MagiCore Prosthetic Components (continued)

Impression Coping (Pick-Up Type)

Abutment Diameter	Type	Height	Code
4.0	Hex	Short	● MPICH40
	Hex	Long	● MPICH40L
4.5	Hex	Short	● MPICH45
	Hex	Long	● MPICH45L
5.5	Hex	Short	● MPICH55
	Hex	Long	● MPICH55L

■ 4.0 abutment available in selected regions only

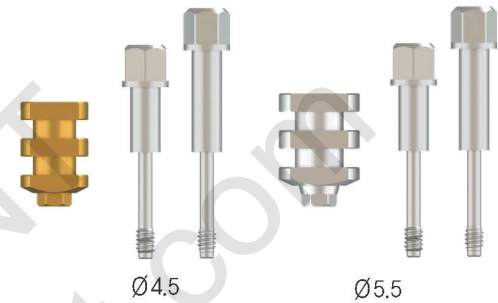
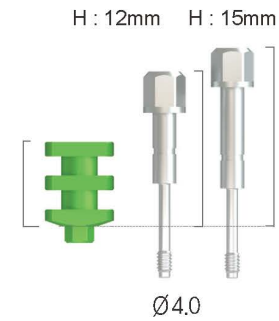

Plastic Coping

Abutment Diameter	Type	Code
4.0	Hex	● MFPC40
4.5		○ MFPC45
5.5		● MFPC55

■ 4.0 abutment available in selected regions only



Burn Out Core Cylinder (Screw-Retained Type)

Abutment Diameter	Type	Color	Code
4.0	Hex	● Green	MPSR40ST
	Non-Hex		MPSR40BT
4.5	Hex	○ White	MPSR45ST
	Non-Hex		MPSR45BT
5.5	Hex	● Black	MPSR55ST
	Non-Hex		MPSR55BT

· Tighten screw to 20N/cm

■ Special Order: ø5.0 / ø6.0

■ 4.0 abutment available in selected regions only



MagiCore Prosthetic Components (continued)

Burn Out Core Cap (Cemented Type)

Abutment Diameter	Type	Color	Code
4.0	Hex	● Green	MPLP40ST
	Non-Hex		MPLP40BT
4.5	Hex	○ White	MPLP45S
	Non-Hex		MPLP45B
5.5	Hex	● Black	MPLP55S
	Non-Hex		MPLP55B



- Special Order: ø5.0 / ø6.0
- 4.0 abutment available in selected regions only

Magic Abutment

Abutment Diameter	Height(H)	Type	
		Hex	Non-Hex
4.0	2	MMG2H4002	MMG2N4002
	4	MMG2H4004	MMG2N4004
	6	MMG2H4006	MMG2N4006
4.5	2	MMG2H4502	MMG2N4502
	4	MMG2H4504	MMG2N4504
	6	MMG2H4506	MMG2N4506
5.5	2	MMG2H5502	MMG2N5502
	4	MMG2H5504	MMG2N5504
	6	MMG2H5506	MMG2N5506

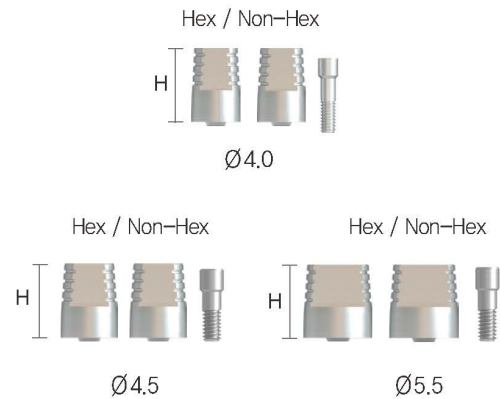

- For ø 4.5, ø 5.5, use 1.2 Hex Driver to tighten screw up to 20N/cm.
- For ø 4.0, use 1.2 Hex Driver to tighten screw up to 15N/cm.

- 4.0 abutment available in selected regions only

MagiCore Prosthetic Components (continued)

Short Abutment

Abutment Diameter	Height(H)	Type	
		Hex	Non-Hex
4.0	3	MMAH4003	MMAN4003
	5	MMAH4005	MMAN4005
4.5	3	MMAH4503	MMAN4503
	5	MMAH4505	MMAN4505
5.5	3	MMAH5503	MMAN5503
	5	MMAH5505	MMAN5505

- For \varnothing 4.5, \varnothing 5.5, use 1.2 Hex Driver to tighten screw up to 20N/cm.
- For \varnothing 4.0, use 1.2 Hex Driver to tighten screw up to 15N/cm.

■ 4.0 abutment available in selected regions only

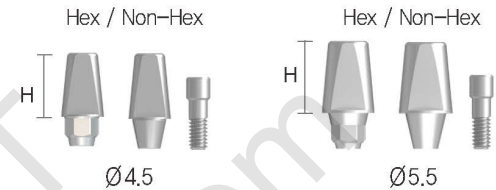

MagiCore Solid Abutment

Abutment Diameter	Height(H)	Code
4.0 (Narrow)	3	MA4003
	5	MA4005
4.5	3	MA4503
	5	MA4505
5.5	3	MA5503
	5	MA5505

- Tightened with 1.2 Hex Driver at 20N/cm

■ 4.0 abutment available in selected regions only

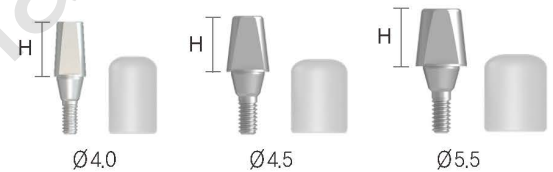

MagiCore Solid Abutment Lab Analog

Abutment Diameter	Height(H)	Code
4.5	3	● MAL453
	5	● MAL455
5.5	3	● MAL553
	5	● MAL555

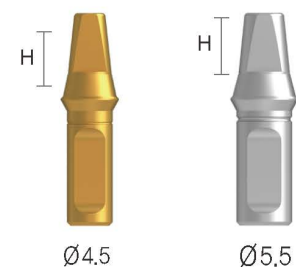

MagiCore Prosthetic Components (continued)

MagiCore Solid Abutment Impression Cap

Abutment Diameter	Code
4.5	○ MSPC45
5.5	● MSPC55



Ø4.5



Ø5.5

CAD / CAM Components

MagiCore Scanbody

Abutment Diameter	Code
4.5	MSB45
5.5	MSB55



Ø4.5



Ø5.5

MagiCore Link(Ti-base)

Abutment Diameter	Type	Code
4.0	Hex	MLH404
	Non-Hex	MLN404
4.5	Hex	MLH454
	Non-Hex	MLN454
5.5	Hex	MLH554
	Non-Hex	MLN554

Hex / Non-Hex



Ø4.0

Hex / Non-Hex



Ø4.5

Hex / Non-Hex



Ø5.5

■ 4.0 abutment available in selected regions only

For Minimally Invasive Implant Surgery

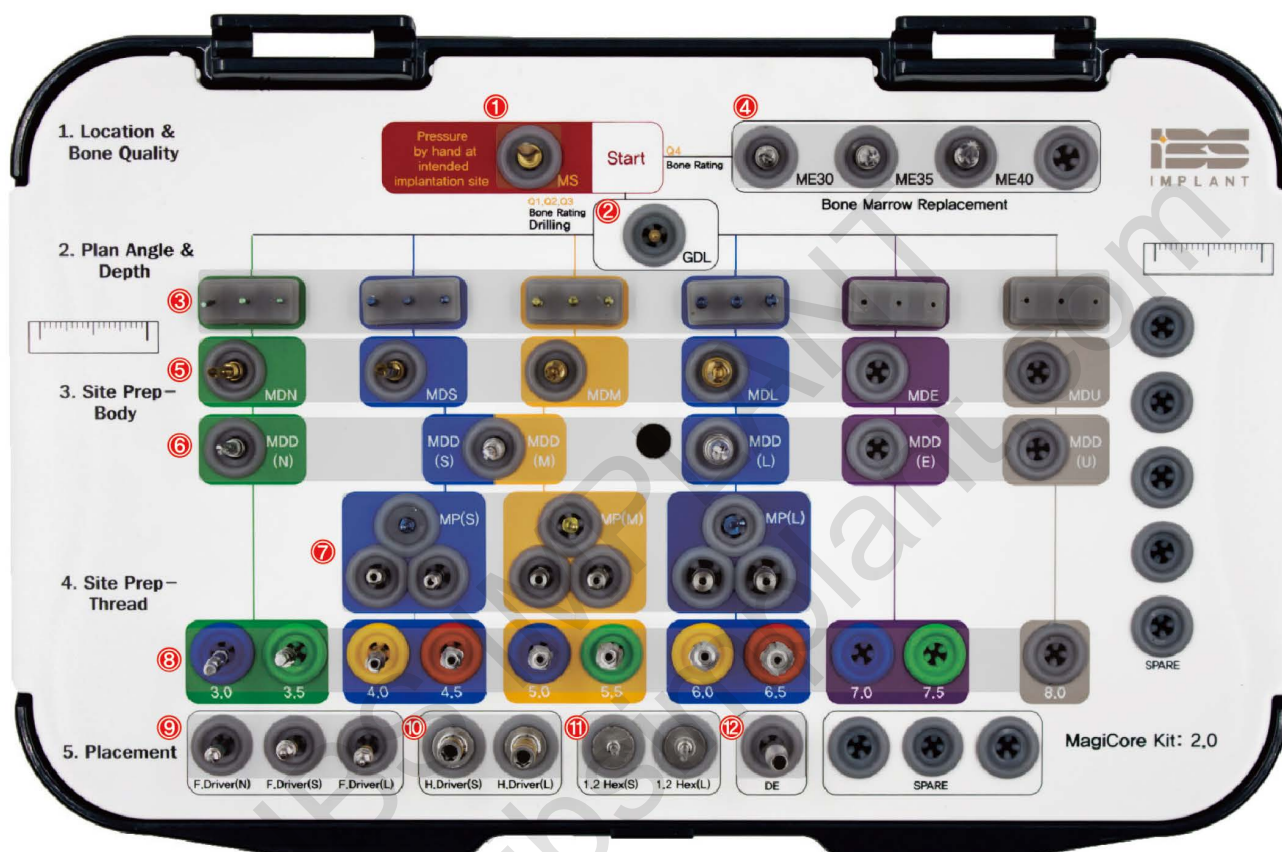

- ① Magic Split
- ② Pin Drill
- ③ Guide Pin
- ④ Magic Expander
- ⑤ Magic Drill
- ⑥ Magic Depth Drill
- ⑦ Magic Pin
 - Magic Body
 - Magic Tap Guide
- ⑧ Magic Tap Drill (4.0/4.5/5.0/5.5/6.0/6.5)
- ⑨ MagiCore Machine Driver
- ⑩ Ratchet Driver
- ⑪ 1.2 Hex Driver
- ⑫ Drill Extension

Magic Fit Drilling Tech.

The Magic Fit Drilling System is a state-of-the-art implant surgery system which allows for high precision from diagnosis to final placement. The tools used in each step allow for error-free drill path management, and create an osteotomy that minimizes bone removal and dramatically reduces damage to tissues during the process. The protocol makes early and immediate loading more predictable and practical.

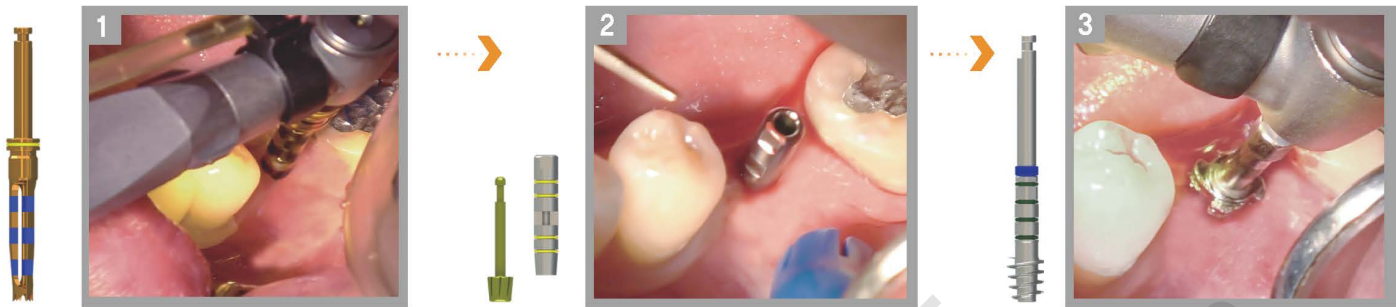

- Drill speed should be greater than 1,500~2,000rpm.
- Intermittent vertical pressure should be applied while maintaining direction (bone dancing).
- Do not apply Up & Down technique.
- Magic Tap Drill should be used at 20rpm and 40N/cm.

B.E.B Tech. (Bone Expansion With Bending of Cortical Bone)

The B.E.B Tech. utilizes the biophysical properties of alveolar bone and a patented specially shaped instrument to safely and conveniently expand bone width and also lift the sinus up to 4mm without the need for grafting. This tech. is highly desirable by clinicians due to its ease of use and effectiveness in achieving desirable effects.

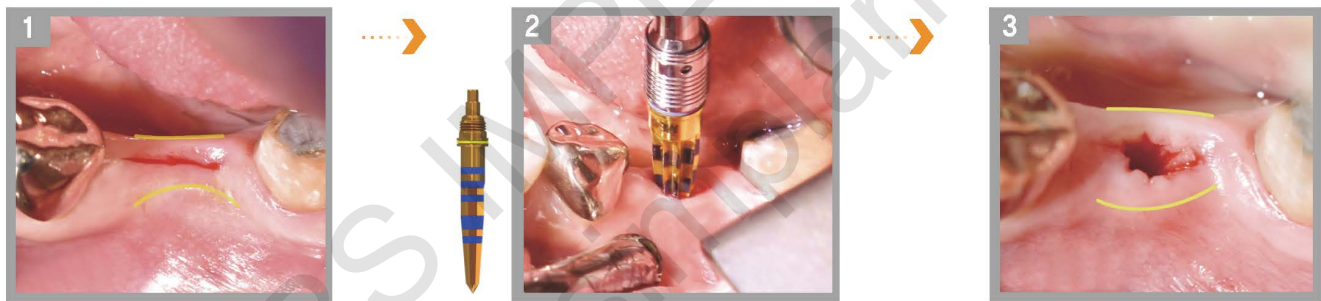

- 2-stage surgery is required and 5 months or more of healing should be allowed.
- If the buccal or lingual wall is too thin or cracks occur during procedure, bone grafting should be performed.
- Malleting should be done with light wrist action only.
- If the instrument shifts or does not advance, drilling should be done to remove dense bone areas before reapplying the Expander.

C.M.C Tech. (Crestal Approach With Membrane Control)

The C.M.C Tech. is a minimally invasive crestal approach sinus augmentation technique which allows the clinician to directly control the exact height and volume of the membrane lift. Since the instrument lifts the membrane to a controlled height exactly above the placement site, there is no need for excessive bone graft material. Since a miniscule hole is formed to insert the instrument, there is even less chance for complications or failures.

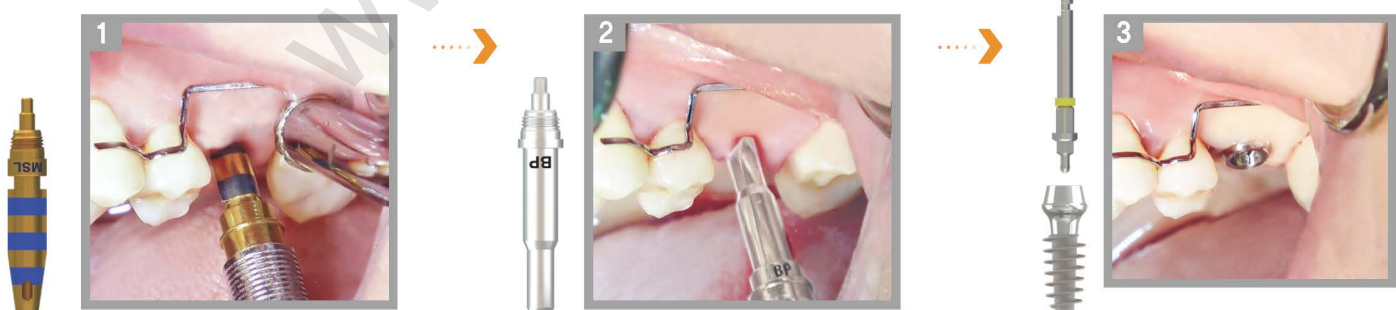

- Make such that the residual bone height is 2mm before applying the Magic Sinus Lifter.
- Malleting should be done with light wrist action only.
- Advance the instrument at a minimal velocity.
- If the instrument does not advance, use the Magic Drill to make further indentation before reapplying the Lifter.

MagiCore Kit Components

Magic Split



Diameter	Code
Ø2.5	MS25S

- Malleting instrument which connects to the Hand Lever.
- Used in the first step of implant surgery to determine bone quality.
- Used as an initial tool in cases when Magic Expanders are used for osteotomy.

Optional

Ø2.5	MS25L
------	-------

- Long Type

Magic Expander

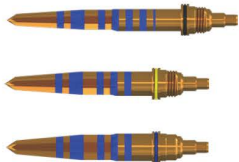

Diameter	Code
Ø3.0	● ME30
Ø3.5	● ME35
Ø4.0	● ME40

- Malleting instrument which connects to the **Hand Lever**.
- Main tools used for B.E.B Tech.
- Patented Star-shape design which reduces condensation forces and minimizes load to bone.

Pin Drill



Length	Diameter	Code
29,5mm	Ø1.0	GDL

- Initial drill used in the first steps of the Fit Drilling Protocol, which makes space for the internal guide to be fixed in place.
- Makes space for Guide Pin to be fixed.

※ Drill in one-stroke and without Up & Down.

- Short Type

Guide Pin

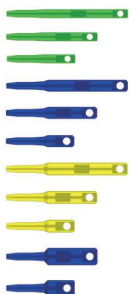

Diameter	Code
Ø2.3	● P23S/P23L
Ø3.3	● P33S/P33L
Ø3.8	● P38S/P38L
Ø4.8	● P48S/P48L

- Fixed in the space made by the **Pin Drill**.
- Serves as an initial path confirmation guide.
- Guides the **Magic Drill** internally, allowing for precise and convenient guided.

Optional (extra long)

Ø2.3	● P23EL
Ø3.3	● P33EL
Ø3.8	● P38EL

■ Ø2.3 available in selected regions only

MagiCore Kit Components (continued)

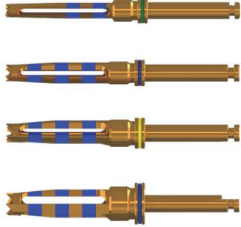

Magic Drill

Diameter	Code
Ø2,3	● MDN
Ø3,3	● MDS
Ø3,8	● MDM
Ø4,8	● MDL

- Drill used to perform osteotomy in hard and soft bone types.
- Hollow design allows for autogenous bone harvesting.
- Recommended lifetime of use: 50 uses
- Recommended drill speed: +1,500rpm~2,000rpm.
- Excessive vertical force reduces cutting ability of drill.

Optional

Ø4,3	MD43
Ø5,3	MD53
Ø5,8	MD58
Ø6,3	MD63

■ MDN available in selected regions only

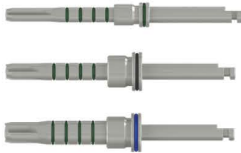

Magic Depth Drill

Diameter	Code
Ø2,0	● MDDN
Ø2,4	● MDD
Ø3,1	● MDDW

- Blades only exist at the tip of the drill.
- Useful tool to determine the condition of the floor of osteotomy.
- In case of hard bone, drill can be used to drill deeper without affecting the shape of the osteotomy.
- Useful in confirming the final depth of osteotomy.

■ MDDN available in selected regions only

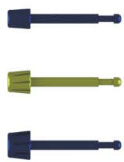

Magic Tap Guide

Length	Diameter	Code
15mm	Ø2,36	● P4
15mm	Ø2,66	● P5
15mm	Ø3,3	● P6

- Used together with the Magic Body to form the Magic Pin.
- Useful for confirming the path and location of osteotomy.
- Guides the Magic Tap Drill, making for precise tap drilling.
- ※ Must not be used in presence of bone marrow space.

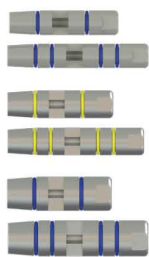

Magic Body

Length	Diameter	Code
13,3mm	Ø2,98	● BS4
17,3mm	Ø2,98	● BL4
13,3mm	Ø3,49	● BS5
17,3mm	Ø3,49	● BL5
13,3mm	Ø4,33	● BS6
17,3mm	Ø4,33	● BL6

- Used together with the **Magic Tap Guide** to form the **Magic Pin**.
- Useful for confirming the path and location of osteotomy
- ※ Must be used after checking for presence of bone marrow space. If bone marrow exists, use without connecting with **Magic Tap Guide**.

MagiCore Kit Components (continued)

Magic Tap Drill

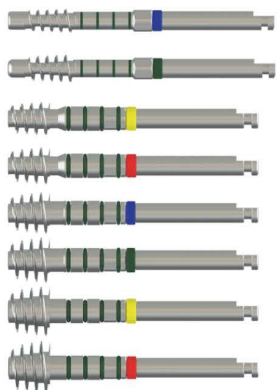

Diameter	Code
Ø3,0	TD30
Ø3,5	TD35
Ø4,0	TD40
Ø4,5	TD45
Ø5,0	TD50
Ø5,5	TD55
Ø6,0	TD60
Ø6,5	TD65

· Used as a final step in "Fit Drilling", this drill forms the space for implant threads to follow.

· Set the motor at 20rpm and 40N/cm.

※ Do not apply vertical or lateral pressure during use.

■ TD30, TD35 available in selected regions only

MagiCore Machine Driver

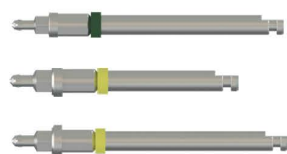

Total Length	Diameter	Code
32mm	Ø2,9	MHMDNL
26mm	Ø3,7	MHMDS
33mm	Ø3,7	MHMDL

· Especially designed for MagiCore, this driver is compatible with both the handpiece and the **Ratchet Driver**.

■ MHMDNL available in selected regions only

Ratchet Driver

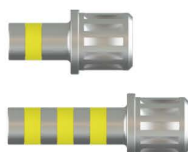

Diameter	Code	
Ø4,5	Short	RDS
Ø4,5	Long	RDL

· Used while connected to the **MagiCore Machine Driver** to place implant by hand. Can be connected to the **Torque Ratchet**.

1.2 Hex Driver



Length	Diameter	Code
17,5mm	Ø7,9	HD1.2S
22,5mm	Ø7,9	HD1.2L

· Used to tighten the Cover Screw and Abutment Screw.

· Can be connected to the Torque Ratchet.

※ Abutment Screws should be tightened to 20N/cm.

MagiCore Kit Components (continued)



Drill Extension

Code
DE

· Connected to the **Magic Drill** to extend its reach.



Torque Ratchet

Length	Diameter	Code
82,9mm	Ø7,0	TRW

· Used to measure exact torque during placement by hand.
· Can measure up to 55N/cm.

※ Must be disassembled, cleaned and dried after use.



Angled Hand Lever

Code
HLA

· Serves as a handle when connected to a malleting instrument.



Bone Remover

Length	Code
100mm	BR

· Used to easily remove bone core from center of **Magic Drill**.



IBS Spoon Excavator

Length	Code
166mm	EXC

· Laser marked to conveniently confirm depth while removing bone core from osteotomy.

· Used to examine the walls of osteotomy.

· Useful for minimally invasive GBR methods such as the Internal Pocket Tech.

Additional Surgical Instruments



Magic Sinus Lifter

Code
MSL

- Malleting instrument which connects to the Hand Lever.
 - Used as a main instrument to perform C.M.C Tech.
 - Patented design has hollow point which enables direct holding of bone block of sinus floor.
 - Designed with double side blades which acts as a slowing mechanism.
- Item ordered separately



Bone Pusher

Code
BP

- Malleting instrument which connects to the **Hand Lever**.
 - Used as a tool to insert graft material evenly into the sinus augmentation.
- Item ordered separately



1.6 Guide Drill

Diameter	Code
Ø1.6	1.6GD

- Used as an initial drill in hard bone before applying the B.E.B Tech.
 - Used to make a hole that guides the advancement of the Magic Split.
- Item ordered separately



Magic Marking Drill

Code
MMD
MMDW

- Used to conveniently mark the location of intended placement location.
 - Instrument's diameter is 5mm, allowing it to be used as a convenient tool for sensing mesiodistal distance.
- Special Order
■ Item ordered separately



Magic Short Drill

Code
MSD

- Used in the posterior region when clearance is not enough to insert a normal drill length.
 - Used as a convenient drill to prepare the bone before applying the C.M.C Tech.
- Item ordered separately



2.8 Magic Drill

Diameter	Code
Ø2.8	MD28

- Used as an initial drill in hard bone before applying the B.E.B Tech.
- Item ordered separately

Additional Surgical Instruments (continued)

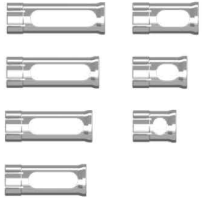

Drill Stopper

Drilling Depth(mm)	Code
1	DS01
2	DS02
3	DS03
4	DS04
7	DS07
9	DS09
11	DS11

· Used as a safety guide for drill depth during osteotomy.

■ Item ordered separately

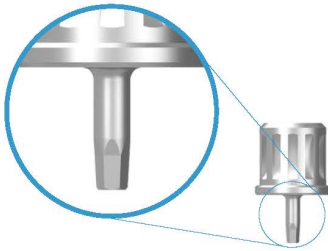

Ultra Short 1.2 Hex Driver

Code

HD1.2US

· Used to remove the Coping Pin during impression coping.

· Used for cases with low clearance.

■ Item ordered separately

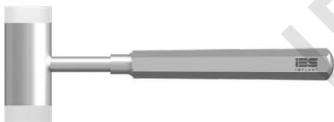

IBS Mallet

Code

HM15

· Mallet used with Hand Lever instruments.

※ Must use gentle tapping with wrist action only.

■ Item ordered separately

Instructions for Connecting Malleting Instruments to the Hand Lever.

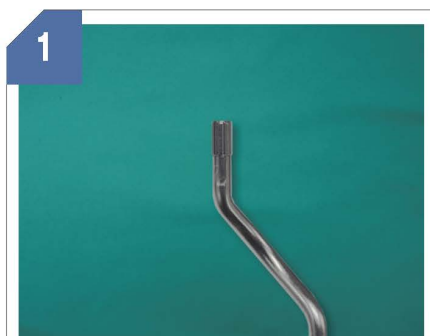

1

Remove from Kit and hold in hand by the handle.

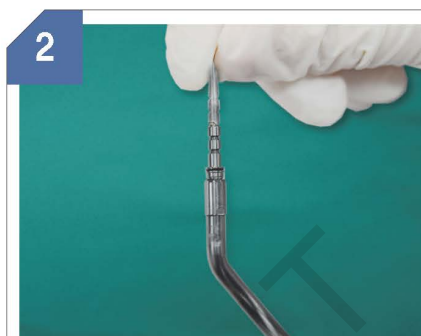

2

Engage the instrument with the Hand Lever with the connection as shown.

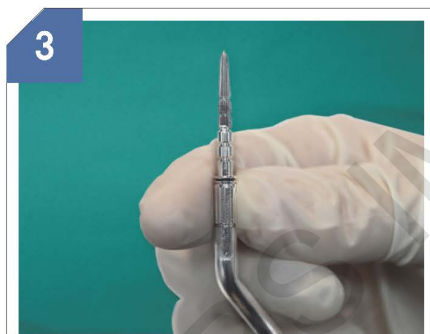

3

After engaging the instrument with the connection, turn the nob counterclockwise to secure the connection.



4

Make sure the instrument is securely fastened to the connection.

Precautions when using the Magic Kit

- **Precaution when securing the malleting instrument to the Hand Lever**
Do not apply excessive lateral force on the instrument after it is fastened.
- **Only use light wrist action when malleting. If the instrument does not advance into bone, use the Magic Drill to remove dense bone parts before reapplying the instrument.**
- **Immediately clean the instrument with cold water after use.**
 - Do not use hydrogen peroxide or saline solution.
 - Ultrasonic cleaning is recommended. (Use a bar stand so that the blades of the instruments do not touch and damage each other.)
- **Store instruments in a dry place after cleaning.**
 - If stored in a hot humid place, instruments may experience corrosion.